

ACCESSORIES

ACCESSORI

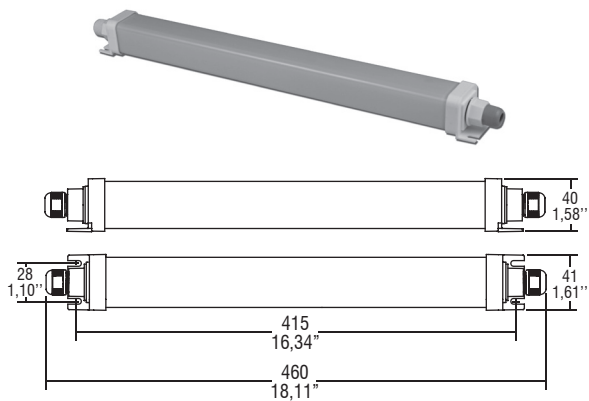

LINEAR BOX IP67

IP67 box for power supplies.

IP67 box suitable for electronic linear power supplies:

- IP6X: dust-tight box.
- IPX7: box protected against the effect of temporary immersion.

Protection CLASS I and II (check indication on the power supply).

Box can be secured with slot for screws.

Ambient temperature $T_a = -20 \dots +55^\circ\text{C}$; verify the T_c point of the internal power supply.

Contenitore IP67 per alimentatori elettronici.

Contenitore per alimentatori elettronici lineari con grado di protezione IP67:

- IP6X: involucro totalmente protetto contro la polvere.
- IPX7: involucro protetto contro gli effetti dell'immersione.





Protezione in CLASSE I e II (dipendente dall'alimentatore utilizzato).



Fissaggio tramite asole per viti.

Temperatura ambiente $T_a = -20 \dots +55^\circ\text{C}$; il punto t_c è indicato sull'alimentatore interno.

Article Articolo	Code Codice	Weight Peso
LINEAR BOX IP67	180066/390	140 gr. - 4,94 oz.

Wire Cavo	Nut type Tipo di dado	Rubber Gommino
Ø 9,6	2	E
Ø 8,0 Ø 7,6 Ø 7,4	2	E
Ø 6,5 Ø 6,2 Ø 5,2	1	A
4,1 x 6,3 4,3 x 6,6	1	B
Ø 2,0	1	C / D

Rubber - Gommino				
hole - foro Ø 6,5	slot - asola 2,5x5,2	2 holes - 2 fori Ø 2	4 holes - 4 fori Ø 2	hole - foro Ø 9,6
white - bianco	transparent - trasparente	yellow - giallo	yellow - giallo	black - nero
A 	B 	C 	D 	E 

Nut type - Tipo di dado	
hole - foro Ø 6,5 / white - bianco	hole - foro Ø 10 / grey - grigio
	

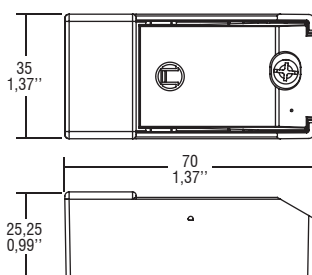
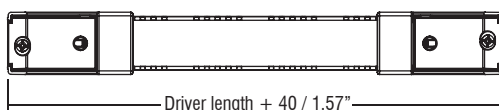
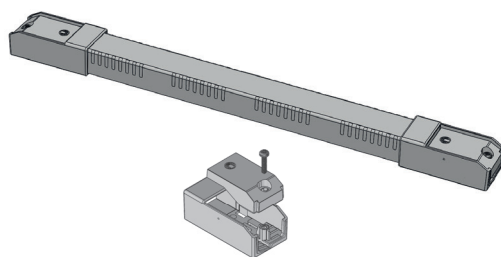

INDEPENDENT TRANSFORMATION KIT

Clamping screw on primary and secondary circuit.

Cables with diameter: min. 3 - max. 8 mm

Material: PC V0 self-extinguishing

Grey RAL 7035

Vite di serraggio per circuito primario e secondario.

Cavi di diametro: min. 3 - max. 8 mm

Materiale: PC V0 autoestinguente

Grigio RAL 7035

Article Articolo
KIT code composition: 488787559K1
Body: 488787559 n.2
Clamp: 488787560 n.2
Screw: 427760020 n.2 (3,4x13mm)

50 KIT minimum - minimo